

"B" EPULET DNY-i középső beépített árkád homlokzat

zámó párkány: 29,54 meter

kváderes íves falburkolat: 36,84 m²

kváderes szabályos falburkolat: 25,12 m²

falburkolat béllet: 35,52 meter

osztópárkány: 13,84 meter

osztópárkány béllet: 2,40 meter

lábazati falburkolat: 9,11 m²

lábazat béllet: 5,76 meter

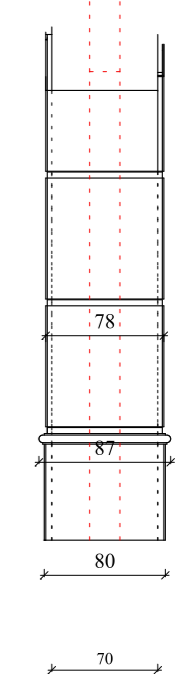
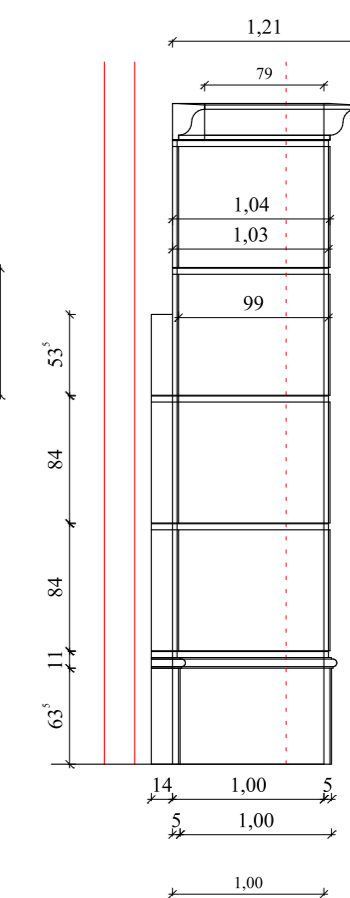
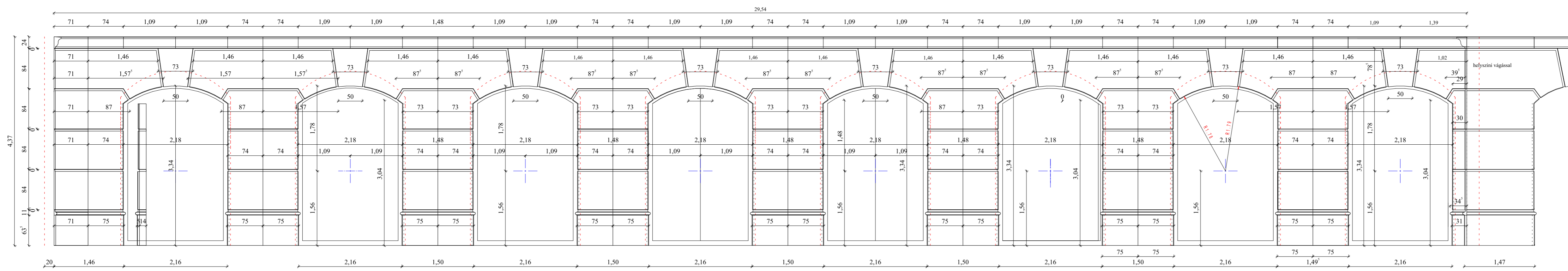
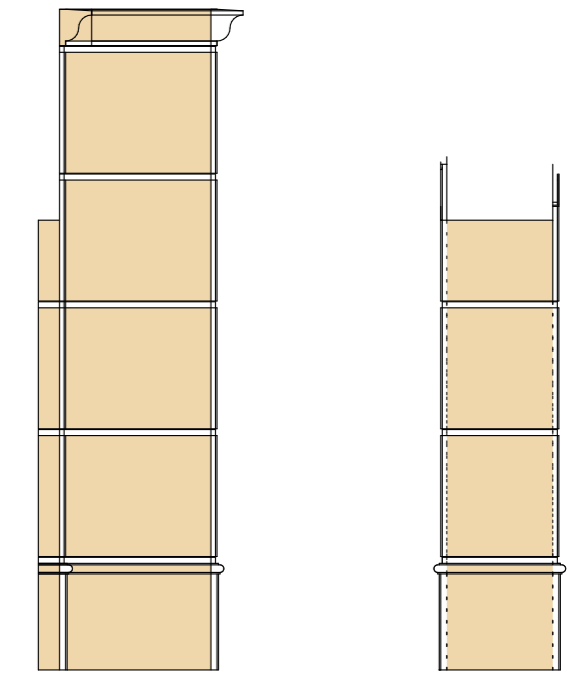
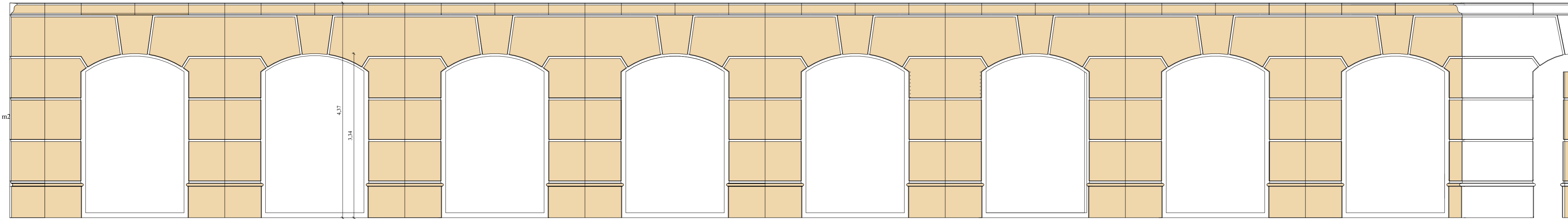

"B" fal

"C" fal

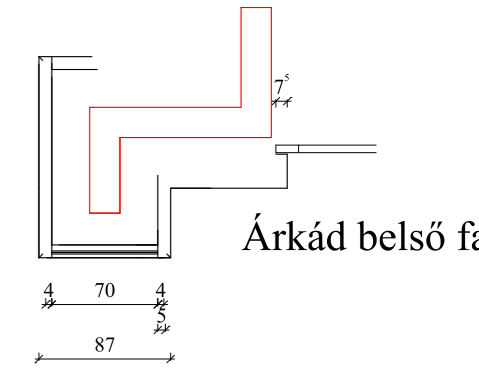
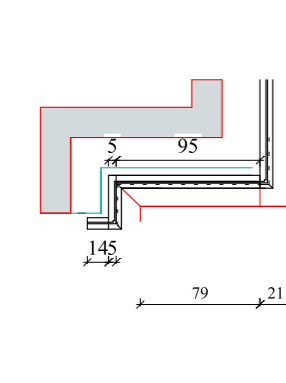
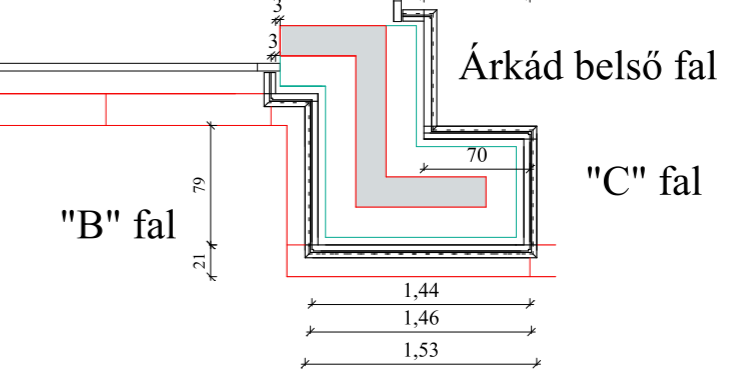
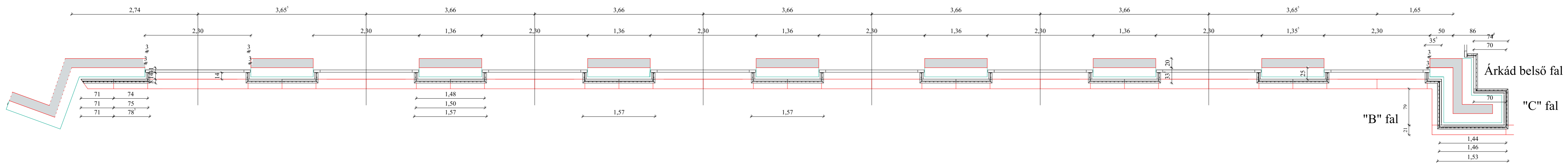

Árkád belső fal

"C" fal

Árkád belső fal